

User Manual

# RISH *Multi* 12S ... 16S

Analog-Digital Multimeter

---



Printed in India, Subject to change without Notice

---

Genius 04/05/2T

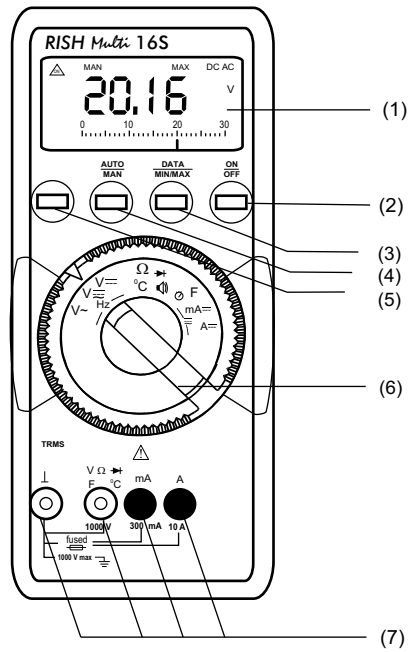

### 19. Servicing

When you need service, please contact :

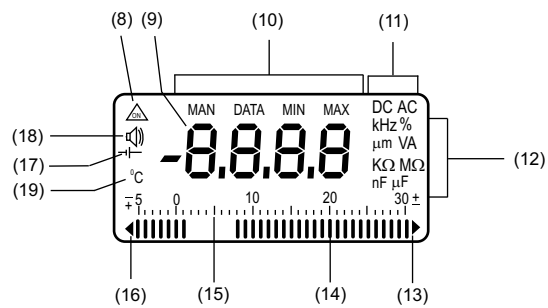

- (1) Liquid crystal display
- (2) ON/OFF pushbutton
- (3) Pushbutton for data hold and MIN/MAX storage functions
- (4) Pushbutton for manual range selection
- (5) Multi function pushbutton
- (6) Function selector switch.
- (7) Terminal sockets with automatic blocking system.
- (8) Symbol for "CONTINUOUSLY ON"
- (9) Display for digits, decimal point and polarity
- (10) Display for manual range selection, DATA hold and MIN/MAX storage.
- (11) Display for the selected function
- (12) Display for the unit of measured quantity
- (13) Over range indication for positive analog range.
- (14) Pointer for analog indication.
- (15) Scale for analog indication
- (16) Over range indication for negative analog range.
- (17) Low battery indication.
- (18) Buzzer indication
- (19) Display °C for temperature measurement range.

Contents	Page
1. Introduction .....	2
2. Safety features and safety precautions .....	2
3. Switching the multimeter "ON" .....	3
4. Function and range selection .....	4
4.1 Switching the DC current measuring ranges on ● .....	4
4.2 Autoranging .....	4
4.3 Manual range selection .....	5
5. Liquid crystal display .....	5
5.1 Digital display .....	5
5.2 Analog indication .....	5
6. "DATA" hold facility .....	6
7. Minimum value and maximum value "MIN/MAX" storage facility. ....	6
8. Voltage measurement .....	7
8.1 Voltage measurement on electrical system upto 1000V with the KS30 measuring adapter .....	9
9. Current measurement .....	9
9.1 AC current measurement with (clip-on) current transformers .....	11
9.1.1 Transformer output mA/A .....	11
9.1.2 Transformer output V .....	11
10. Resistance measurement .....	11
11. Diode test and continuity test .....	13
12. Capacitance measurement (Rish multi 15S and 16S) .....	14
13. Frequency measurement (Rish multi 15S and 16S) .....	14
14. Duty cycle measurement (Rish multi 15S and 16S) .....	15
15. Temperature measurement .....	15
16. Computer interface via RS-232C .....	16
17. Specifications .....	18
18. Maintenance .....	26
18.1 Battery .....	26
18.2 Fuses .....	27
18.3 Case .....	27
19. Servicing .....	29

## 1. Introduction:

Thank you very much for selecting this Multimeter.  
This handheld multimeters are suitable for use in the fields of general electronics and electrical engineering.  
These multimeters are manufactured as per DIN 43751

## 2. Safety features and safety precautions

You have chosen a multimeter which provides you a very high degree of safety. The analog-digital multimeters *RISH Multi* 12S ...16S are manufactured and tested in compliance with the safety standard DIN VDE0411 and IEC 1010-1/DIN EN61010-1/VDE0411-1. In case of incorrect use or careless handling, the safety of both user and multimeter is not assured

For proper use and safe handling, it is absolutely necessary to read and understand the operating instructions before using the meter.

For your safety and for protection of the multimeter, the *RISH Multi* 12S...16S multimeters are fitted with an Automatic terminal Blocking System (ABS). It is coupled with the function selector switch which blocks the terminal sockets not necessary for measurement.

### Please note the following safety precautions:

- The multimeter must be operated only by persons who understand the danger of shock hazards and are aware of the necessary safety precautions. Shock hazards exist wherever voltages of more than 30V (TRMS) are present.
- Do not work alone in shock hazardous environment while carrying out measurement.
- The maximum permissible voltage between any of the terminal sockets (7) and ground is 1000V. But voltages of more than 500V must be applied only to the unblocked sockets on the voltage measuring ranges (function selector switch (6) set to a "V position")
- Take into account that unexpected voltages can occur on device under test (e.g. defective instrument). For example, capacitors may be charged to a dangerously high voltage.
- Verify that the test leads are in good condition, e.g. no cracked insulation, no open circuits in the leads or connectors.
- This multimeter must not be used for measurements on circuits with corona discharge (high voltage).
- Be particularly careful when measuring on HF circuits. Dangerous composite voltages may exist there.
- Measurements under moist environmental conditions are not permitted.
- All current measuring ranges, with the exception of the 16A range of *RISH Multi* 13S, are protected with fuse. The maximum permissible voltage of the measuring circuit (=nominal voltage of the fuse) is 500V ~ on the "mA" ranges, 600V ~ on the "A" ranges.
- You must use the "multimeter" only in power systems, when the current circuit is protected by a fuse or a circuit breaker of 20A, and when the nominal voltage of the system does not exceed 500V
- For safe voltage measurements in power systems upto 1000V we recommend the KS30 measuring adapter, which is available as an accessory. Its internal resistance limits the measuring current in the case of overvoltage, in correct operation and safely suppresses sparking from spark gap. Also refer to Section "8.1 Voltage measurement on electrical systems up to 1000V with KS30 measuring adapter.

## Replacing the battery

- Place the multimeter on its face, loosen the two screws on the rear and remove the lower part of the case, lifting it from the bottom. The lower and the upper part of the case are fixed together at the top on the front by means of wedges.
- Remove the battery from the battery compartment and carefully disconnect battery connectors.
- Snap the battery connectors to a new 9 V battery and insert the battery into the battery compartment.
- Replace the lower part of the case. Start at the top on the front and take care that the wedges are properly engaged at this point.
- Tighten the lower part with the two screws.  
Please destroy the batteries in an environment friendly way

## 18.2 Fuses

A blown fuse is signalled on the LCD display the instant a measured quantity having a voltage of more than 4V is applied to the corresponding connection sockets.

Then, the digital display (9) shows " FUSE"

The 16 A fuse protects the 3 A and 10 A ranges, the 1.6 A protects all other current measuring ranges. All other measuring ranges continue to function.

When a fuse blows, first eliminate the cause of the overload before using the multimeter again !

### Fuse replacement

- Open the multimeter same as for battery replacement
- Remove the blown fuse, e.g. with the aid of a probe, and replace it with a new one.

Permissible types

-- for current measuring ranges up to 300 mA:

Fast blowing fuse type 1.6 A / 500 V: 6.3 mm x 32 mm.

-- for the 3 A and 10 A current measuring ranges:

	Type	Dimensions
Normal fuse	16 A / 600 V~	10 mm x 38 mm

### Caution :

Absolutely verify that only the specified fuse is installed!

If a fuse of other cut-out capacity, other nominal current or other switching capacity is used, a dangerous situation exists, and there is danger of damaging protective diodes, resistors or other components.

The shorting of the fuse holder is not permissible.

### 18.3 Case

Special maintenance of the case is not required. Take care that the surface between the connection sockets is clean. For cleaning take a moist cloth. Avoid scrubbing.

Response time (after manual range selection)

Measured quantity/ measuring range	Response time		Transient response for step function of the measured quantity
	of analog indication	of digital display	
V $\overline{\sim}$ ; V $\sim$ , A $\overline{\sim}$ ; A $\sim$	0.7 s	1.5 s	from 0 to 80 % of upper range limit
30 $\Omega$ ... 3 M $\Omega$	1.5 s	2 s	from $\infty$ to 50 % of upper range limit
30 M $\Omega$	4s	5 s	
$\rightarrow$	0.7 s	1.5 s	
nF $\mu$ F $^{\circ}$ C		max. 1...3 s	from 0 to 50 % of upper range limit
300 Hz, 3 kHz		max. 2 s	
30, 100 kHz		max. 0.7 s	
% (1 Hz)		max. 9 s	
% ( $\geq$ 10Hz)		max. 2.5 s	

#### Interface

Type RS232C, serial, as per DIN 19241  
 Data transmission Optically with infrared light through the case  
 Baud rate 8192 bits/s

#### Ambient conditions

Functional temperature range -10  $^{\circ}$ C...+ 50  $^{\circ}$ C  
 Storage temperature range -25  $^{\circ}$ C...+70  $^{\circ}$ C without batteries  
 Climatic class 2z/-10/50/70/75 % with reference to VDI/VDE 3540  
 Altitude up to 2000 m

#### Mechanical configuration

Protection type IP 50, for the connection sockets IP 20  
 according to DIN VDE 0470 Part 1 /EN 60529  
 Dimensions 84 mm x 195 mm x 35 mm  
 Weight 350 g approx.,including battery

## 18. Maintenance

### Caution

*Disconnect the meter from the measuring circuit before you open it to replace the battery or the fuse !*

### 18.1. Battery

Prior to initial start-up, or after storage of multimeter, verify that the battery of multimeter does not leak. Repeat this check in regular short intervals. If the battery leaks, completely remove the battery electrolyte carefully with a moist cloth and install a new battery before you operate multimeter again.

When the symbol "  $\text{---}$  " (17) appears on the LCD (1) replace the battery as soon as possible. Measurement can be done, but a reduced measuring accuracy must be taken into account.

The multimeter operates with a 9 V flat cell battery according to IEC 6 F 22 or IEC 6 LR 61 or with a suitable NiCd storage battery

Meaning of the symbols on the device



Warning of a danger point  
(Attention, refer to the user manual)



Earth (ground) terminal.



Double or reinforced insulation

### Repair, replacement of parts:

When opening the meter, live parts may be exposed. Therefore, the meter must be disconnected from the measuring circuit prior to opening its case for repair or replacement of parts. If repair cannot be avoided unless the meter is opened and live, this work must only be performed by a qualified person who understands the danger involved.

### Faults and abnormal stress:

When it is realised that the safe operation is no longer possible, take the meter out of service and secure it against accidental use.

Safe operation may not be possible,

- when the meter shows obvious signs of damage,
- when the meter no longer functions correctly,
- after prolonged storage under adverse conditions,
- due to severe stress during transportation.

## 3. Switching the multimeter "ON"

### Battery

We have already fitted your meter with a 9 V flat cell battery according to IEC 6 F 22 or IEC 6 LR 61. It is ready for operation. *Before you use the meter for the first time or after storage, refer to Section "18.1 Maintenance-Battery".*

### Switching the meter "ON"

- Press the "ON/OFF" pushbutton (2).  
 Switch-"ON" is acknowledged by a sound signal. As long as you keep the pushbutton pressed, all segments of the liquid crystal display (LCD) will appear. The LCD is shown on page 1.  
 After the pushbutton is released, the meter is ready for operation.

### Note:

Electric discharges and high-frequency influence may cause incorrect information to be displayed and block the measuring process. Reset the meter by switching it OFF and ON again otherwise, check the battery connections.

Disconnect the meter from the measuring circuit before you open it, and see section "18.Maintenance" !

#### Automatic TURN-OFF

The meter turns off automatically, when the measured value remains constant (variations of the measured value  $\leq \pm 2$ digits) for about 10 minutes and when neither a pushbutton nor the function selector switch is operated during that time. It remains ON, however, when a current measuring range is selected and a measured value  $> 30$ digits is displayed.

#### How to prevent automatic TURN-OFF

In order to prevent automatic "TURN OFF" select "CONTINUOUSLY ON" mode. For this, press yellow multi-function pushbutton (5) and the "ON/OFF" pushbutton (2) together. The function "CONTINUOUSLY ON" is shown on the LCD (1) by the symbol  (8).

#### Turning the multimeter OFF

Press the "ON/OFF" pushbutton (2).

#### 4. Function and range selection

The function selector switch (6) is coupled with the Automatic terminal Blocking System (ABS) which allows access only to two correct sockets for each function. Prior to switching to the "mA" or "A" functions or from the "mA" or "A" functions, remove the test lead from the corresponding socket. When the test leads are plugged-in, the terminal blocking systems prevents accidental switching to nonpermissible functions.

##### 4.1 Switching the DC current measuring ranges ON " "

3 mA for RISH Multi 12S

3 mA and 3 A for RISH Multi 13S

300  $\mu$ A, 30 mA and 3 A for RISH Multi 14S...16S

The current measuring ranges mentioned above are not automatically selected when the meter in switched ON. When you need these measuring ranges for your measurements, you must additionally activate them.

- set the function selector switch (6) to "  " (yellow symbol)
  - Briefly press the yellow multi-function pushbutton (5).  
The multimeter acknowledges the start of an offset calibration for these DC current measuring ranges with a sound signal. The digital display (9) of the multimeter shows "CAL" during the calibration procedure.
  - Wait for "CAL" to disappear from the display.  
Thereafter, the above current measuring ranges are switched "ON". They remain switched-ON until the multimeter turns OFF automatically or is switched OFF manually.
- Note:**
- Automatic turn-OFF is inactive on all current measuring ranges when the measured value display exceeds 30 digits.  
Set the function selector switch (6) to the desired position.

##### 4.2 Autoranging

The multimeters feature autoranging for all measuring ranges with the exception of the 30 mV  $\overline{\text{---}}$ , 300 mV  $\overline{\text{---}}$  and 10 A  $\sim$  ranges. Autoranging is automatically selected after switching the multimeter ON. According to the measured quantity applied, the multimeter automatically selects the measuring range which gives the best resolution. When switching to frequency measurement and to ratio measurement, the previously selected voltage measuring range is maintained.

Influence quantity	Range of Influence	Measured quantity/ Measuring range	Variation  12 S...16S
Battery voltage	$\overline{\text{---}}$ <sup>5)</sup> ... < 7.9 V > 8.1 V ... 10.0V	V $\overline{\text{---}}$	$\pm 2$ Digit
		V $\sim$	$\pm 4$ Digit
		A $\overline{\text{---}}$	$\pm 4$ Digit
		A $\sim$	$\pm 6$ Digit
		30 $\Omega$ / 300 $\Omega$ / $^{\circ}$ C	$\pm 4$ Digit
		3 k $\Omega$ $\overline{\text{---}}$ 30 M $\Omega$	$\pm 3$ Digit
		nF, $\mu$ F	$\pm 1$ Digit
		Hz	$\pm 1$ Digit
		%	$\pm 1$ Digit
Relative humidity	75 %	V $\approx$	1 x intrinsic error
	3 days	A $\approx$	
	Meter off	$\Omega$	
		F	
DATA	—		$\pm 1$ Digit
MIN/MAX	—	V $\overline{\text{---}}$ , A $\approx$	$\pm 2$ Digit

- 1) With temperature : Error data apply per 10 K change in temperature.  
With frequency : Error data apply to a display from 300 digits onwards.
- 2) With zero adjustment.
- 3) With unknown waveform (crest factor CF > 2), measure with manual range selection.
- 4) With the exception of sinusoidal waveform.
- 5) After the "  $\overline{\text{---}}$  " symbol is displayed.

Influence quantity	Range of Influence	Measuring ranges	Attenuation
Common mode interference voltage	Noise quantity max. 1000 V $\sim$  50 Hz, 60 Hz sinusoidal	V $\overline{\text{---}}$	> 120 dB
		3V $\sim$ , 30 V $\sim$	> 80 dB
		300 V $\sim$	> 70 dB
		1000 V $\sim$	> 60 dB
Normal mode interference voltage	Noise quantity V $\sim$ value of the measuring range at a time max. 1000 V $\sim$ , 50 Hz, 60 Hz. sinusoidal	V $\overline{\text{---}}$	> 50 dB
		Noise quantity max. 1000 V $\overline{\text{---}}$	V $\sim$

Influence Quantities and Variations

Influence quantity	Range of Influence	Measured quantity/ Measuring range	Variation <sup>1)</sup> ± (...% of rdg. + ... digits)		
			12 S...14S	15 S	16 S
Temperature 0 °C +21 °C and +25 °C...+40 °C		30/300 mV ---		1.0+3	1.0+1
		3...300V ---		0.15+1	0.1+1
		1000V ---		0.2+1	0.1+1
		V ~		0.4+2	0.3+2
		300 µA <sup>2)</sup> ...		0.5+1	0.15+1
		300 mA ---			
		3A / 10 (16) A ---		0.5+1	
		A ~		0.75+1	0.75+3
		30 Ω <sup>3)</sup>		0.15+2	
		300 Ω		0.25+2	0.15+2
		3K Ω - 3MΩ		0.15+1	0.1+1
		30 MΩ		1.0+1	0.6+1
		30 nF <sup>3)</sup> - 3 µF		-	0.5+2
		30 µF		-	2.0+2
		Hz		-	0.5+1
		%		-	±5 Digit
-200 ... +200 °C			0.5 K+2		
+200 ... +850 °C			0.5+2		
Frequency of the measured quantity		15 Hz ... < 30 Hz	-	-	1.0+3
		30 Hz... < 45 Hz	-	-	0.5+3
		> 65 Hz... 400 Hz		2.0+3	0.5+3
		> 400 Hz... 1 kHz	3 ... 300V ~	2.0+3	1.0+3
		> 1 kHz... 20 kHz		-	2.0+3
		15 Hz... < 30 Hz	1000V ~	-	1.0+3
		30 Hz... < 45 Hz		-	0.5+3
		> 65 Hz... 1 kHz		3.0+3	2.0+3
		15 Hz... < 30 Hz	A ~	-	1.0+3
		30 Hz... < 45 Hz		-	0.5+3
> 65 Hz... 1 kHz		2.0+3	3.0+3		
Wave form of the measured quantity		Crest. factor CF	1...3	-	± 1 % of rdg.
		> 3...5	V ~ <sup>4)</sup> , A ~ <sup>4)</sup>	-	± 3 % of rdg.
<p>The permissible crest factor CF of the AC quantity to be measured is a function of the displayed value :</p> <div style="display: flex; justify-content: space-around;"> <div style="text-align: center;"> <p>Voltage measurement</p> </div> <div style="text-align: center;"> <p>Current measurement</p> </div> </div>					

The meter switches automatically to :  
 the next higher range at ± (3099 digits + 1 digit)  
 the next lower range at ± (240/280 digits - 1 digit)  
 from the 300mA --- to the 3mA --- range at ± (24 digits - 1 digit)  
 provided the 300 µA, 30 mA and 3 A ranges are not selected according to section 4.1

**4.3 Manual range section**

You can switch OFF autoranging and select the ranges manually according to the table on the following page.  
 Manual mode is switched OFF when pushbutton AUTO/MAN is pressed (4) for approximately 1s, when the function selector switch (6) is operated, or when the meter is turned OFF and ON again.  
 When switching back to autoranging from 30 mV --- or 300 mV --- ranges, 3 V --- range is automatically selected.

AUTO/MAN (4)	Function	Acknowledgement Display	Sound Signal
Short	Manual mode on : Used range is fixed	MAN (10)	1 x
Short	Switching sequence at : V - : 3V → 30V → 300V → 1000V → 30 mV → 300 mV → 3 V → ... V - / --- : 3V → 30 V → 300 V → 1000 V → 3V → ... mA - : 300µA <sup>1)2)</sup> → 3mA → 30mA <sup>1)</sup> → 300 mA → 300µA <sup>1)2)</sup> mA ~ / --- : 3 mA <sup>2)</sup> → 30 mA <sup>3)</sup> → 300 mA → 3 mA <sup>2)</sup> ... A - : 3A <sup>1)</sup> → 10 A → 3 A <sup>1)</sup> ... Ω : 30MΩ → 30kΩ → 300Ω → 3 kΩ → 30 kΩ → 300kΩ → 3 MΩ → 30MΩ ... F : 30 nF → 300 nF → 3 µF → 30 µF → 30 nF ... Hz: 300 Hz → 3kHz → 30kHz → 100kHz → 300Hz...	MAN (10)	1 x
Long	Return to autoranging	-	2 x

- 1) When these measuring ranges are selected
- 2) except for RISH Multi: 12S/13S
- 3) except for RISH Multi: 14S...16S

**5. Liquid crystal display**

**5.1 Digital display**

The digital display (9) shows the measured value with correct location of decimal point and sign. The selected measuring Unit (12) and the function (11) are simultaneously displayed. When measuring DC quantities, a minus sign appears in front of the digits, when the positive pole of the measured quantity is applied to the "L" input terminal. When upper range limit 3099 (on the range →: 1999), is exceeded then "OL" is displayed. With V, A and Ω measurements, the digital display is updated two times per second.

**5.2 Analog indication**

The analog indication with pointer presentation gives the dynamic response of a moving-coil movement and is updated 20 times per second, when measuring V, A and Ω. Analog indication is of particular advantage when observing variations of measured values and for calibration procedures.

The analog indicator has its own polarity indication. When measuring DC quantities, the analog scale (15) has a negative range of 5 scale

divisions so that variations of the measured values around "zero" can be observed exactly. When the measured value exceeds the range of indication, the left triangle (16) is shown before the polarity of the analog indicator switches over after approximately 0.7s. The over range indication on the measuring range (> 3099 digits, on the range →>1999) is shown by the right triangle (13).

## 6. "DATA" hold facility

The DATA function allows to automatically hold the measured values. This is particularly useful, for instance, when connecting the probes to the measuring point requires full attention. When the measured value is applied and the "condition" according to the table shown below is met, the meter holds the measured value on the digital display and emits a sound signal. The probes can now be removed from the measuring point and the measured value on the digital display (9) can be read. When the measured value falls below the limit specified in the table, the meter is reactivated for a new storage.

The analog indication is not influenced by the DATA hold. The actual measured value can still be noted / read. Note that with a held digital display the location of the decimal point is also held. With autoranging selected, the measuring range of the analog indicator is no longer known.

Function DATA	↓ DATA MIN / MAX (3)	Condition		Meter acknowledgement Display		
		Measuring Ranges	Limit of Measured Values (digits)	Meas. Value digital	DATA	Sound Signal
Activate	Short				flashes	1 x
Store		V ~ <sup>2)</sup> A ~ Ω FHz, %	>280 >24 <sup>3)</sup> < OL >280	dis- played	dis- played	1 x
Reactive <sup>1)</sup>		V ~ <sup>2)</sup> A ~ Ω FHz, %	< 280 < 24 <sup>3)</sup> OL < 280	stored mea- sured value	flashes	
Reset	Long			Cleared	Cleared	2 x

- 1) Reactivated by falling below the specified limits of the measured value.
- 2) With the exception of the ranges 30 mV and 300 mV
- 3) 240/280 digits when the ranges 3 mA for *RISH Multi-12S/13S* and 300 μA, 40 mA, 3 A for *RISH Multi-14S...16S* are selected according to section 4.1.

As long as the DATA hold function is active, manual range selection is not possible. The DATA hold function is switched OFF when,

- ☛ The "DATA" pushbutton (3) is pressed for approx. 1s. This is acknowledged by 2 sound signals.
- ☛ The function selector switch (6) is operated or
- ☛ The multimeter is turned OFF and ON again.

## 7. Minimum value and Maximum value "MIN/MAX" storage facility

With the MIN/MAX function, you can hold the minimum and the maximum measured value which was applied to the input of the multimeter after activating MIN/MAX function. The most important application is the determination of the minimum and the maximum value for long-term monitoring of measured quantities. MIN/MAX does not influence the analog indication. The actual measured value can still be noted/read. Apply the measured quantity to the meter and select the measuring range prior to activating the MIN/MAX function.

With the function activated, you can select the measuring ranges only manually. If you switch to another range, the stored MIN/MAX values are cleared.

## Display

Liquid crystal display section (65 mm x 30 mm) with analog indication and digital display and with display of the unit of measured quantity function and various special functions.

### Analog :

Indication	LCD scale with pointer
Scale length	55 mm on V --- and A ---, 47 mm on all other ranges
Graduation	± 5...0... ± 30 with 35 scale divisions on ---, 0...30 with 30 scale divisions on all other ranges
Polarity indication	with automatic change-over
Overrange indication	by triangle (13)
Sampling rate	20 readings/s, on Ω ; 10 readings/s

### Digital:

Display/Height of numer.	7-segment numerals/15mm
Number of digits	3 <sup>34</sup> digit ≥ 3100 counts
Overrange	"OL" is displayed.
Polarity indication	"-" sign is displayed, when the positive pole is at " ⊥ "
Sampling rate	2 reading/s, on Ω and °C: 1 reading/s

### Power supply

Battery	9V flat cell battery; manganese-dioxide cell according to IEC 6 F 22, alkaline-manganese cell according to IEC 6 LR 61 or suitable NiCd storage battery
Lifespan	With alkaline-manganese cell: approx. 750 hours on V ---, A --- approx. 200 hours on V ~, A ~ (12S...15S) approx. 150 hours on V ~, A ~ (16 S) When operating with interface: times x 0.7
Battery test	automatic display of the " ⊥ " symbol, when the battery voltage drops below approx. 7 V

### Electrical safety

Protection class	II according to IEC 348 / DIN VDE 0411 and IEC 1010-1/EN61010-1/VDE0411-1
Overvoltage category	II III
Nominal voltage	1000V 600V
Contamination degree	2
Nominal insulation	voltage 1000V according to IEC 348 / DIN VDE 0411
Test voltage	6kV - according to IEC 348/DIN VDE0411
EMC	Electromagnetic compatibility
Emission	EN50081-1:1992 / EN55022:1987 class B
Immunity	EN50082-1:1992 / IEC801-2:1991 8kV AD / IEC801-3:1984 3V/m / IEC801-4:1988 0.5kV

### Fuses

#### Fuse for upto 300mA ranges

Fast blowing 1.6 A / 500V; 6.3 mm X 32 mm; rating 20kA with 500 V~ and ohmic load; in conjunction with power diodes, protects all current measuring ranges upto 300 mA.

#### Fuse for upto 10A ranges

16 A / 600 V; 10 mm x 38 mm; rating 100 kA with 600 V ~ and ohmic load; protects the 3 A and 10 A ranges upto 600 V; see "18. maintenance" for manufacturers and types of fuses.

Measuring voltage for resistance measurement

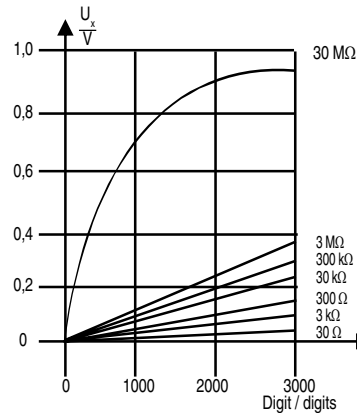

Voltage  $U_x$  across the resistance  $R_x$  to be measured as a function of measuring range and display.

Measuring current for diode test or continuity test

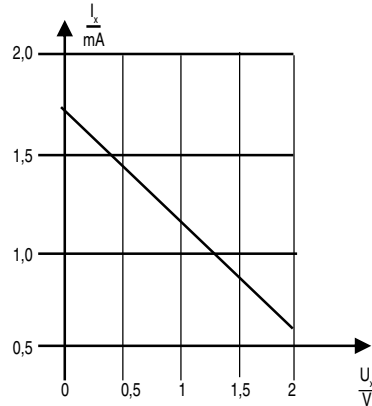

Measuring current  $I_x$  as a function of the displayed voltage  $U_x$  across the device under test

Reference conditions

Ambient temperature :  
+ 23 °C ± 2 K

Relative humidity :  
45% ... 55 % RH

Frequency of measured quantity  
45Hz ... 65 Hz

Waveform of the measured quantity  
sinusoidal

Battery voltage  
8V ± 0.1 V

Function MIN / MAX	↓ DATA MIN / MAX (3)	Meas- uring ranges	Measured Values MIN and MAX	Meter acknowledgement		
				Display Meas. Value digital	MIN MAX	Sound Signal
1. Activate and Store	2 x Short, 30 mV/ 300 mV and °C 1 x short	V ≈ A ≈ Ω FHz, % °C	Stored	actual meas- ured value	MIN and MAX flash	1 x
2. Store and display	↓ short	V ≈ A ≈ Ω FHz, % °C	Storage Continued in the background, new MIN / MAX values are displayed	stored MIN value	MIN	1 x
	↓ short			stored MAX value	MAX	1 x
3. Return to 1.	↓ Short	Same as 1.	Same as 1., Stored Values are not cleared	same as 1.	same as 1.	1 x
Reset	↓ Long		Cleared	Cleared	Cleared	2 x

The MIN/MAX function is switched OFF, when the MIN/MAX pushbutton (3) is pressed for approximately 1s, or when the function selector switch (6) is operated, or when the meter is turned OFF and ON again.

## 8. Voltage measurement

- According to the voltage to be measured, set the function selector switch (6) to V ~, V --- or V ≡.
- Connect the test leads as shown. The "⊥" socket should be connected to the lowest potential ground available.

### Notes :

The 30 mV --- and 300 mV --- measuring ranges can only be selected manually with the "AUTO/MAN" pushbutton (4) !  
On the 1000 V range, an intermittent sound signal warns you, when the measured value exceeds the upper range limit.

### Caution :

Ensure current measuring range ("mA" or "A") is not selected for voltage measurement ! When the cut-out rating of the fuses is exceeded because of incorrect operation, a dangerous situation exists!.

### Zero adjustment on the 30 mV --- measuring range

- Connect the test leads to the meter and join the free ends. After having selected the measuring range, briefly press the yellow multifunction pushbutton (5). The meter acknowledges zero setting by a sound signal, the LCD shows "00.00" (+ 1 digit) and the decimal point flashes. The displayed value at the instant the pushbutton is pressed, is used as reference value (max ± 200 digits) it is automatically deducted from the values measured thereafter.

- The zero adjustment is cleared when ;
- By pressing the yellow multifunction pushbutton (5) for a long time, clearance is acknowledged by the two sound signal.
- By switching the instrument OFF.

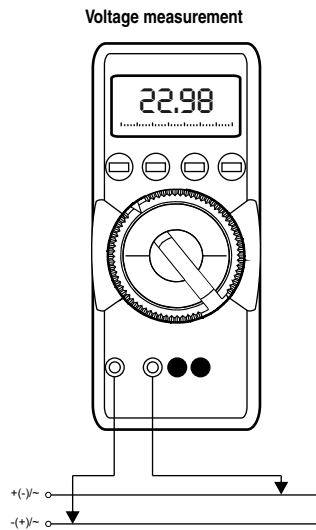

**Voltage measurement on electrical systems up to 1000 V  
with the KS30 measuring adapter**

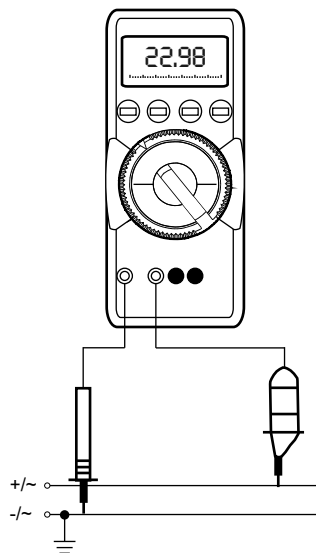

	Intrinsic error of digital display ± (...% of reading, + ... digits) at reference conditions					Overload Capacity <sup>3)</sup>	
	12S	13S	14S	15S	16S	Overload value	Overload duration
	-	-	-	1.0 + 3 <sup>4)</sup>		500 V DC / AC eff / rms sine	10 min
	-	-	-	1.0 + 3			
	-	-	-	1.0 + 3			
	-	-	-	3.0 + 3			
	-	-	-	0.5 + 1 <sup>7)</sup>		≤3 kHz; 1200 V ≤30 kHz; 300 V ≤100 kHz 30 V	continuously
	-	-	-				
	-	-	-				
	-	-	-				
	-	-	-	1 Hz... 1 kHz ± 5 Digit <sup>8)</sup> 1 kHz ...10 kHz; ± 5 Digit/kHz <sup>8)</sup>			
	2 Kelvin + 5 Digit <sup>9)</sup>					500 V	10 min
	1.0 + 5 <sup>9)</sup>					DC	
	2 Kelvin + 2 Digit <sup>9)</sup>					AC eff/rms sine	
	1.0 + 2 <sup>9)</sup>						

7) Range 3V  $\approx$  :  $U_E = 1.5 V_{\text{eff/rms}} \dots 100 V_{\text{eff/rms}}$

30V  $\approx$  :  $U_E = 15 V_{\text{eff/rms}} \dots 300 V_{\text{eff/rms}}$

300V  $\approx$  :  $U_E = 150 V_{\text{eff/rms}} \dots 1000 V_{\text{eff/rms}}$

8) On the range 3V  $\approx$ , square-wave signal positive on one side 5 ... 15 V,  
f = const., not 163.84 Hz or integral multiple.

9) Without sensor.

Measurement Function	Measuring Range					Resolution	Discharge Resistance	U <sub>0 max</sub>
	RISH Multi	12 S	13 S	14 S	15 S			
F	30.00 nF				● ●	10 pF	250 k Ω	2.5 V
	300.0 nF				● ●	100 pF	250 k Ω	2.5 V
	3.000 μF				● ●	1 nF	25 k Ω	2.5 V
	30.00 μF				● ●	10 nF	25 k Ω	2.5 V
							f <sub>min</sub> V <sub>---</sub>	f <sub>min</sub> V <sub>~</sub>
Hz	300.0 Hz				● ●	0.1 Hz	1 Hz	45 Hz
	3.000 kHz				● ●	1 Hz	1 Hz	45 Hz
	30.00 kHz				● ●	10 Hz	10 Hz	45 Hz
	100.0 kHz				● ●	100 Hz	100 Hz	100 Hz
%	2.0...98.0%				● ●	0.1 %	1 Hz	-
°C	pt 100	-200.0... +200.0 °C	● ● ● ● ●			0.1 °C	-	-
		+200.0... +850.0 °C	● ● ● ● ●			0.1 °C	-	-
	pt 1000	-100.0... +200.0 °C	● ● ● ● ●			0.1 °C	-	-
		+200.0... +850.0 °C	● ● ● ● ●			0.1 °C	-	-

3) At °C ... + 40 °C

4) With zero adjustment; without zero adjustment + 50 digits.

### 8.1 Voltage measurement on electrical systems up to 1000V with the KS30 measuring adapter.

On low-voltage systems, transient overvoltages of several kilovolts can occur due to switching functions or lightning discharges. Direct connection of your multimeter to such systems for voltage measurement can be dangerous.

For voltage measurements in power systems with nominal voltages up to 1000V use the KS30 measuring adapter. It is an adapter for multimeter which eliminates dangers caused by overvoltages and incorrect operation of the multimeter. It provides the following protective functions..

- ☛ Protection of the input circuit of voltage measuring range of multimeters. The internal resistance of the KS30 limits the current in the case of overvoltage.
- ☛ Overload capacity : continuously 1200 Vrms  
Transient (rise 10 μs/fall 1000 μs) 6 kV max.
- ☛ Safe suppression of sparking from spark plug after overvoltage.
- ☛ Current limitation in the case of incorrect operation (e.g. applying a voltage to a current input)

Voltages above 1000V can be measured with a high-voltage probe, provided the necessary safety precautions are taken !

### 9. Current Measurement

- ☛ First disconnect the power supply to the circuit being measured and/ or to the load, and discharge all capacitors within that circuit.
- ☛ Select the DC current measuring ranges as described in section 4.1
- ☛ With the function selector switch (6), select A<sub>---</sub> for currents >300 mA, and mA<sub>---</sub> for currents <300 mA. When measuring current of unknown magnitude, select the highest measuring range first.
- ☛ Select the function corresponding to the measured quantity by briefly pressing the yellow multi-function pushbutton (5). Each time the pushbutton is pressed, alternate switching takes place between DC and AC on the RISH Multi 12S...15S or between DC and (DC + AC) on the RISH Multi 16S. The change-over is acknowledged by a sound signal. The symbols DC and AC (11) are displayed as per selected function on the LCD.

When selecting a range with the function selector switch (6), the DC function is always set by default. When pressing the yellow multi-function pushbutton (5) for a long time, the multimeter always switches back to DC and acknowledges this by two sound signals.

- ☛ Connect the multimeter in series with the load, as shown. Ensure that the connections are tight (without contact resistance).

#### Notes on Current measurement :

- The multimeter must be used only in the power systems, where the current circuit is protected by a fuse or a circuit breaker of 20 A, and when the nominal voltage of the system does not exceed 500V
- Make the measuring circuit connections mechanically strong and secure so that they do not accidentally open. The conductor cross sections and connection points should be designed to avoid excessive heating.
- On the 300 mA and 10 A ranges (16 A range for RISH Multi 13S), an intermittent sound signal warns you, when the measured value exceeds the upper range limit.
- The current measuring ranges up to 300 mA are protected to a short

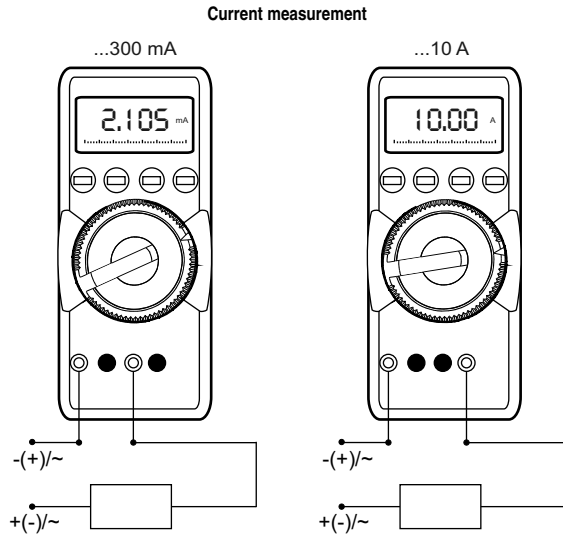

**AC current measurement with (clip-on) current transformers**

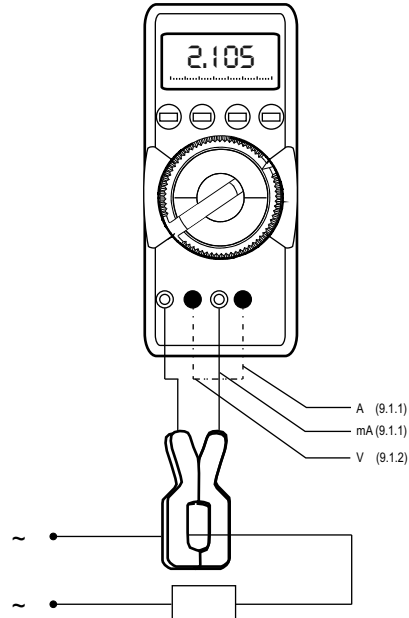

Intrinsic error of digital display ± (...% of rdg. + ...digits) at reference conditions					Overload capacity 3)	
					Overload Value	Overload duration
12 S	13 S	14 S	15 S	16 S		
0.5 + 3 <sup>4)</sup>				0.5 + 3 <sup>4)</sup>	1200 V	Continuously
0.5 + 3				0.5 + 3		
0.25 + 1				0.1 + 1		
0.25 + 1				0.1 + 1		
0.35 + 1				0.1 + 1		
0.75 + 2 (10...300 Digit) 0.75 + 1 (> 300 Digit)				0.75 + 3 (> 10 Digit)	DC	
-	-	-	-	0.75 + 3 (> 10 Digit)	AC eff/rms	
-	-	-	-		sine wave	
-	-	-	-			
-	-	-	-			
-	-	1.0 + 5 (> 10 Digit)	0.5 + 5 (> 10 D)	0.36 A	5)	
1.0 + 5 (> 10 D)	1.0 + 2	0.5 + 2				
0.25 + 2	-	1.0 + 5 (> 10 Digit)	0.5 + 5 (> 10 D)			
1.0 + 2		0.5 + 2				
-	1.0 + 5 (> 10 Digit)	1.0 + 5 (> 10 D)		6)	6)	
-	1.0 + 2	1.0 + 2				
-	-	1.5 + 2 (> 10 Digit)	-	0.36 A	5)	
1.5 + 2 (> 10 Digit)	-	-	-			
-	1.5 + 2 (> 10 Digit)	-	-	6)	6)	
1.5 + 2 (> 10 Digit)	-	-	-	0.36 A	5)	
-	-	-	-	1.5 + 4 (> 10 D)		
-	-	-	-	1.5 + 4 (> 10 D)	12A	5 min
-	-	-	-	1.75 + 4 (> 10 D)		
0.5 + 3 <sup>4)</sup>				0.4 + 3 <sup>4)</sup>	500 V	10 min
0.5 + 3				0.4 + 3		
0.4 + 1				0.2 + 1		
0.4 + 1				0.2 + 1		
0.4 + 1				0.2 + 1		
0.6 + 1				0.4 + 1		
2.0 + 1				2.0 + 1		
0.25 + 1				0.1 + 1		

5) Continuously

6) *Rish Multix*: 13S (Without 16 A fuse!) : 16 A continuously 20 A 5 min  
*Rish Multix*: 14S ... 16S: 12 A 5 min, 16 A 30 s

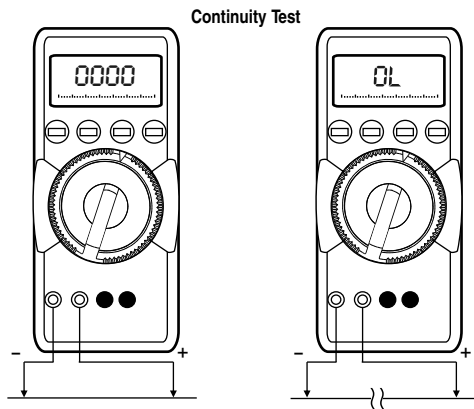
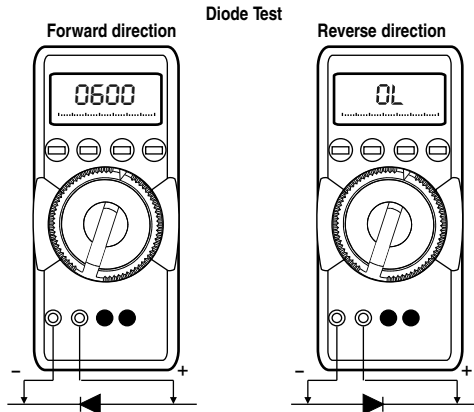
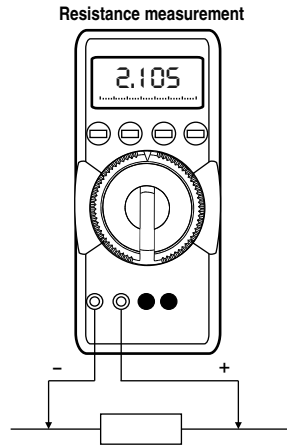

**Software :**

- MS WINDOWS 3.0 or higher.

**Hardware :**

- IBM compatible PC with 1 MB main memory for the WINDOWS version.
- A VGA or EGA monitor.
- A hard disk with 2 MB free storage space.
- A 3.5 " disk drive for disks with 1.44 MB storage capacity
- A MICROSOFT -compatible mouse
- If you wish to make hardcopy a printer supported by WINDOWS.

## 17. Specifications

Measurement Function	Measuring Range					Resolution	Input impedance			
	RISH Multi	12 S	13 S	14 S	15 S			16 S		
V $\overline{\sim}$	30.00 mV	●	●	●	●	●	10 $\mu$ V	> 10 G $\Omega$ // < 40 pF		
	300.0 mV	●	●	●	●	●	100 $\mu$ V	> 10 G $\Omega$ // < 40 pF		
	3.000 V	●	●	●	●	●	1 mV	11 M $\Omega$ // < 40 pF		
	30.00 V	●	●	●	●	●	10 mV	10 M $\Omega$ // < 40 pF		
	300.0 V	●	●	●	●	●	100 mV	10 M $\Omega$ // < 40 pF		
	1000 V	●	●	●	●	●	1 V	10 M $\Omega$ // < 40 pF		
V $\sim$	3.000 V	●	●	●	●	● <sup>1)</sup>	1 mV	11 M $\Omega$ // < 40 pF		
	30.00 V	●	●	●	●	● <sup>1)</sup>	10 mV	10 M $\Omega$ // < 40 pF		
	300.0 V	●	●	●	●	● <sup>1)</sup>	100 mV	10 M $\Omega$ // < 40 pF		
	1000 V	●	●	●	●	● <sup>1)</sup>	1 V	10 M $\Omega$ // < 40 pF		
	3.000 V					● <sup>1)</sup>	1 mV	11 M $\Omega$ // < 40 pF		
	30.00 V					● <sup>1)</sup>	10 mV	10 M $\Omega$ // < 40 pF		
V $\overline{\sim}$	300.0 V					● <sup>1)</sup>	100 mV	10 M $\Omega$ // < 40 pF		
	1000 V					● <sup>1)</sup>	1 V	10 M $\Omega$ // < 40 pF		
	Voltage drop approx.									
								12 S	13 S	14 S / 15S / 16 S
A $\overline{\sim}$	300.0 $\mu$ A			●	●	●	100 nA	-	-	15 mV
	3.000 mA	●	●	●	●	●	1 $\mu$ A	15 mV	15 mV	150 mV
	30.00 mA	●	●	●	●	●	10 $\mu$ A	150 mV	150 mV	650 mV
	300.0 mA	●	●	●	●	●	100 $\mu$ A	1V	1V	1V
	3.000 A		●	●	●	●	1 mA	-	100 mV	100 mV
	10.00 A		16A	●	●	●	10 mA	-	300 mV	270 mV
A $\sim$	3.000 mA			●	●		1 $\mu$ A	-	-	150 mV
	30.00 mA	●	●				10 $\mu$ A	150 mV	150 mV	-
	300.0 mA	●	●				100 $\mu$ A	1 V	1 V	1 V
	10.00 A		16A	●	●		10 mA	-	300 mV	270 mV
A $\sim$ $\infty$	30.00 A <sup>2)</sup>	●					10 mA	150 mV	-	-
	300.0 A <sup>2)</sup>	●					100 mA	1V	-	-
A $\overline{\sim}$	3.000 mA					● <sup>1)</sup>	1 $\mu$ A	-	-	150 mV
	30.00 mA					● <sup>1)</sup>	100 $\mu$ A	-	-	1V
	10.00 A					● <sup>1)</sup>	10 mA	-	-	270 mV
No load voltage										
$\Omega$	30.00 $\Omega$	●	●	●	●	●	10 m $\Omega$	max. 3.2 V		
	300.0 $\Omega$	●	●	●	●	●	100 m $\Omega$	max. 3.2 V		
	3.000 k $\Omega$	●	●	●	●	●	1 $\Omega$	max. 1.25 V		
	30.00 k $\Omega$	●	●	●	●	●	10 $\Omega$	max. 1.25 V		
	300.0 k $\Omega$	●	●	●	●	●	100 $\Omega$	max. 1.25 V		
	3.000 M $\Omega$	●	●	●	●	●	1 k $\Omega$	max. 1.25 V		
	30.00 M $\Omega$	●	●	●	●	●	10 k $\Omega$	max. 1.25 V		
$\rightarrow$ 2.000 V	●	●	●	●	●	1 mV	max. 3.2 V			

- 1) TRMS measurement
- 2) Display with (clip-on) current transformers 1000 : 1
- 3) At 0° ... + 40°C
- 4) With zero adjustment, without zero adjustment + 35 digits

circuit current of 25 A by a fuse 1.6 A/500 V in conjunction, with power diodes. The cut-out capacity of the fuse is 20kA at a rated voltage of 500V $\sim$  and ohmic load.

- The 3 A and 10 A current measuring ranges are protected by a 16A/600V fuse. The cut-out capacity of the fuse is 100 kA at a normal voltage of 600 V  $\sim$  and ohmic load.

### Caution:

The measuring ranges 3A and 16 A of RISH Multi 13S are not protected by a fuse!

- ☛ A blown fuse is signalled on the LCD the instant a measured quantity having a voltage of more than 4 V is applied to the corresponding connection sockets. Then, the digital display (9) shows the word " FUSE"
- ☛ After a fuse has blown, eliminate the cause of the overload before using the meter again !
- ☛ Replacement of the fuses is described in section " 18. Maintenance".

## 9.1 AC current measurement with (clip-on) current transformer

### 9.1.1 Transformer output mA/A

#### Caution:

If current transformers are operated with an open circuit on the secondary side, e.g. due to defective or disconnected leads, a blown fuse in the meter, or a wrong connection, dangerously high voltages can occur at the connectors. Therefore, verify that the current circuit of the multimeter and secondary winding of transformer connected to the multimeter form an intact circuit. Connect the transformer to the sockets  $\perp$  and mA and / or A.

The maximum permissible operating voltage is the nominal voltage of the current transformer. When reading the measured value, take into account the transformer ratio and the additional error in indication.

#### Transformer output RISH Multi 12S

The RISH Multi 12S shows the switching position "  $\infty$  A" and the corresponding sockets. Connect to this socket a (clip-on) current transformer with a transmission ratio of 1000:1; then the measured values are displayed directly in the "A" range.

### 9.1.2 Transformer output V

Many transformers have voltage output (referred as mV/A)

The secondary output must therefore be connected to the connection sockets  $\perp$  and V

## 10. Resistance measurement

- ☛ Verify that the device under test is electrically dead. External voltages would falsify the measured result !
- ☛ Set the function selector switch (6) to " $\Omega$ ".
- ☛ Connect the device under test as shown.

## 12. Capacitance measurement (RISH Multi 15S and 16S)

- Verify that the device under test is electrically dead. External voltages would falsify the measured results !
- Set the function selector switch (6) to "F"
- Connect the (discharged !) device under test to the " 1 " and "F" sockets via test lead.

### Notes:

Connect polarised capacitors with the " − " pole to the " 1 " socket. Resistors and semiconductor junctions in parallel with the capacitor falsify the measured results!

### Zero adjustment on the 30 nF measuring range

When measuring small capacitance values on the 30 nF range, the internal resistance of the multimeter and the capacitance of the leads can be eliminated by zero adjustment.

- Connect the test leads to the meter without device under test.
- Briefly press the yellow multi-function pushbutton (5).  
The meter acknowledges zero adjustment by a sound signal, by displaying "00.00" (+1 digit) on the LCD and by a flashing decimal point. The capacitance measured at the instant the pushbutton is pressed is used as reference value (max. 200 digits). It is automatically deduced from the values measured thereafter.

The zero adjustment can be cleared

- By pressing the yellow multi-function pushbutton (5) for a long time, clearance is acknowledged by the two sound signal.
- By switching the multimeter off.

## 13. Frequency measurement ( RISH Multi 15S and 16S)

Frequency measurement is possible on all voltage measuring ranges in AC, DC and (AC+DC) modes.

- Set the function selector switch (6) to  $V_{\sim}$ ,  $V_{\sim}$  or  $V_{\sim}$
- Connections are made the same way as for voltage measurement, See foot note (8) on page 21.
- Briefly press the yellow multi-function pushbutton (5)  
The multimeter switches to frequency measurement. The frequency is displayed on the LCD.

See section "17. Specifications" for the lowest measurable frequencies and the maximum permissible voltages.

### Changing over between voltage, frequency and duty cycle measurement

Repeated brief pressing of the yellow multi-function switch (5) changes the measuring functions in the following order:

Voltage → frequency → duty cycle → voltage ...

From frequency or duty cycle measurement, directly switching back to voltage measurement is possible.

- by pressing the yellow multi-function pushbutton (5) for a long time. The meter acknowledges this by two sound signals. The voltage measuring range last selected is maintained.
- by operating the function selector switch (6).

## 14. Duty cycle measurement (RISH Multi 15S and 16S)

With duty cycle measurement, we can determine the ratio of pulse duration to cycle time of recurring square-wave signals.

- Set the function selector switch (6) to  $V_{\sim}$  or  $V_{\sim}$
- Connections are made in the same way as for voltage measurement (See foot note 8) on page 21.  
Briefly press the yellow multi-function pushbutton (5) twice. The meter switches to duty cycle measurement. The duty cycle - that is the percentage pulse duration of a signal - is displayed on the LCD in %

- That is :  
$$\text{Duty cycle (\%)} = \frac{\text{Pulse duration}}{\text{Cycle duration}} \times 100$$

### Notes :

The applied frequency must remain constant during the duty cycle measurement. Change -over between voltage, frequency and duty cycle factor measurement is done as described in the preceding section.

## 15. Temperature measurement

The RISH Multi 12S...16S allows you to measure temperature with Pt 100 and Pt 1000 temperature sensors in the range from - 200 (-100)°C...+850°C.

- ☛ Set the function selector switch (6) to " Ω "
- ☛ Connect the sensor to the two unblocked terminals.
- ☛ Briefly press the yellow multifunction pushbutton (5).  
The multimeter switches to temperature measurement, it automatically detects the connected sensor (Pt 100 to Pt 1000) and shows the measured temperature in °C on the digital display

### Notes:

This measurement automatically considers the lead resistance of temperature sensors which are available as accessory .

It is not possible to switch over to temperature measurement when the 30Ω resistance range is selected.

### Sensor lead resistance up to 50 Ω

Lead resistance of sensors having a value differing from that of sensors can be considered up to a value of 50 Ω as follows:

- ☛ Briefly press the yellow multi-function pushbutton (5) again.  
The LCD now displays the resistance value which the multimeter automatically considers after selecting the temperature measuring range. We can recognise that this is the resistance correction value on the temperature measuring range. The " °C " character is simultaneously shown on the display.
- ☛ You can set the lead resistance correction value as follows:  
Press the DATA-MIN/MAX pushbutton (3) to increment the value, or the AUTO/MAN pushbutton (4) to decrement the value. Each time the pushbutton is briefly pressed, the value changes by one digit.
- ☛ Briefly press the yellow multi-function pushbutton (5) again.  
The LCD displays the measured temperature. The flashing decimal point shows you that we have entered a correction value for the lead resistance. The correction value is retained as long as multimeter is switched on.

- Each time the yellow multi-function pushbutton (5) is briefly pressed, the display changes between measured temperature and correction value of the lead resistance.

We can exit the temperature measurement function

- by pressing the yellow multi-function switch (5) longer, this is confirmed by the two sound signals.
- by changing the function selector switch.

**Note:**

For the lead resistance, the actual value measured on the digital multimeter should be taken as correction value and not any specified value.

**16. Computer interface via RS 232C**

The *RISH Multi S* multimeters are fitted with a serial RS-232C interface for transmission of measured data to computer. The measured values are optically transmitted through the case with infrared light to an interface adapter which is attached to the multimeter. The measured data is passed to the computer via a cable.

**Switching the interface ON**

- When switching on the multimeter, press the "ON/OFF" pushbutton (2) and the "DATA-MIN/MAX" pushbutton (3) together.

With interface switched ON, automatic turn-OFF of the meter is inactive. This is shown on the LCD (1) by flashing of the  (8) symbol. The "DATA" function cannot be activated.

**Interface packs as accessories**

**Interface adapter with memory :**

By using this adapter it is possible to store the measured data without interfacing the multimeter to the computer. This stored data can be transferred later on to a computer. For establishing a powerful multimeter system you can connect upto ten multimeters offline. Online connection upto six multimeters to the computer is possible via memory adapter.

The interface packs include the adapters, the necessary connection cables and the "RISH com 100" data acquisition and evaluation software with operating instructions.

**RISH com 100 software**

The **RISHcom 100** software package consists of a WINDOWS version.

With RISH com 100, you can simultaneously access, store, display and document the measured data of several *RISH Multi S* multimeters.

The measured values are presented :

- As digital display and analog indication similar to that of the multimeter. (up to 4 multimeters)
- In traces (XY and Yt) as on a 4-channel recorder.
- In tabular form (data logger : upto 10 channels).

The measured data is stored in ASCII format for further processing. For the use of RISH com 100, the following requirements must be met :

**Zero adjustment on the 30Ω measuring range**

When measuring small resistance values on the 30 Ω range, you can eliminate the resistance of the leads and contact resistance by zero adjustment.

- Connect the test leads to the multimeter and join the free ends.
- Briefly press the yellow multi-function pushbutton (5). The meter acknowledges zero adjustment by a sound signal, the LCD shows "00.00" (+1 digit) and the decimal point flashes. The resistance measured at the instant the pushbutton is pressed is used as reference value (max. 200 digits) It is automatically deducted from the values measured thereafter. Zero adjustment can be cleared.
- By pressing the yellow multifunction pushbutton (5) for a long time and is acknowledged by two sound signals.
- By switching the multimeter OFF.

**11. Diode test and continuity test**

- Verify that the device under test is electrically dead. External voltages would falsify the measured results !
- Set the function selector switch (6) to "→"
- connect the device under test as shown.

Forward direction and/or short circuit:

The multimeter displays the forward voltage in Volts. As long as the voltage drop does not exceed the maximum display value of 1.999V you can also test several series-connected elements or reference diodes with small reference voltage.

Reverse direction or open circuit:

The multimeter indicates overrange "OL"

**Note:**

Resistors and semiconductor junction in parallel with the diode falsify the measured results!

**Diode test and continuity test with buzzer**

With the "buzzer" function selected, the meter emits a continuous sound signal on the range 0...approx. 1V

To switch the buzzer ON:

- Briefly press the yellow multi-function pushbutton (5).
- The multimeter acknowledges turn-ON with a sound signal. At the same time, the symbol  (18) appears on the LCD.

**To switch the buzzer OFF**

- Briefly press the yellow multi-function pushbutton (5) again.
- The multimeter acknowledges turn-OFF with a sound signal. The symbol  (18) disappears from the LCD.

When selecting the function "Diode test and continuity test" with the function selector switch (6), the buzzer is always switched OFF. Repeated brief pressing of the multifunction pushbutton (5) alternately switches the buzzer on and off. When pressing the push button for a long time, the buzzer is always switched OFF, this is acknowledged by the buzzer sounding twice.